

φ 10 mm

Max 10 kg

A	B	C (mm)		D
1	S174-006	1296	596	1/1
2	S174-1108	1284	350	1/1
3	S174-201	600	350	1/1
4	S174-301	567	331	1/1
5	S174-302	567	321	1/1
6	S174-303	567	321	1/1
7	S174-551	233	200	1/1
8	S174-553	391	260	1/1
9	S174-703-01	900	350	1/1
10	S174-704	184	350	1/1
11	S174-7714	175	200	1/1
12	S174-9901	1285	577	1/1
13	qc11/1			1/1

60 min

qc11/1

cm

3x  a2	3x  b1	1x  c34212	4x  d1 φ 5x17 mm	9x  e47 φ 5x16 mm	4x  p21 φ 4x30 mm	16x  f1 φ 8x30 mm	2x  f35 φ 10x50 mm	4x  f6 φ 8x50 mm	2x  j30 M4x22 mm	18x  l1	10x  l2	2x  n122
2x  o21 silikon	9x  o54 φ 5.3/φ 8.3x4.8 mm	4x  p17 φ 5x60 mm	24x  r1 φ 15x12 mm #16	4x  r10	16x  r42	24x  s2 φ 16	2x  n10					



2

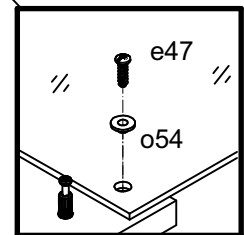
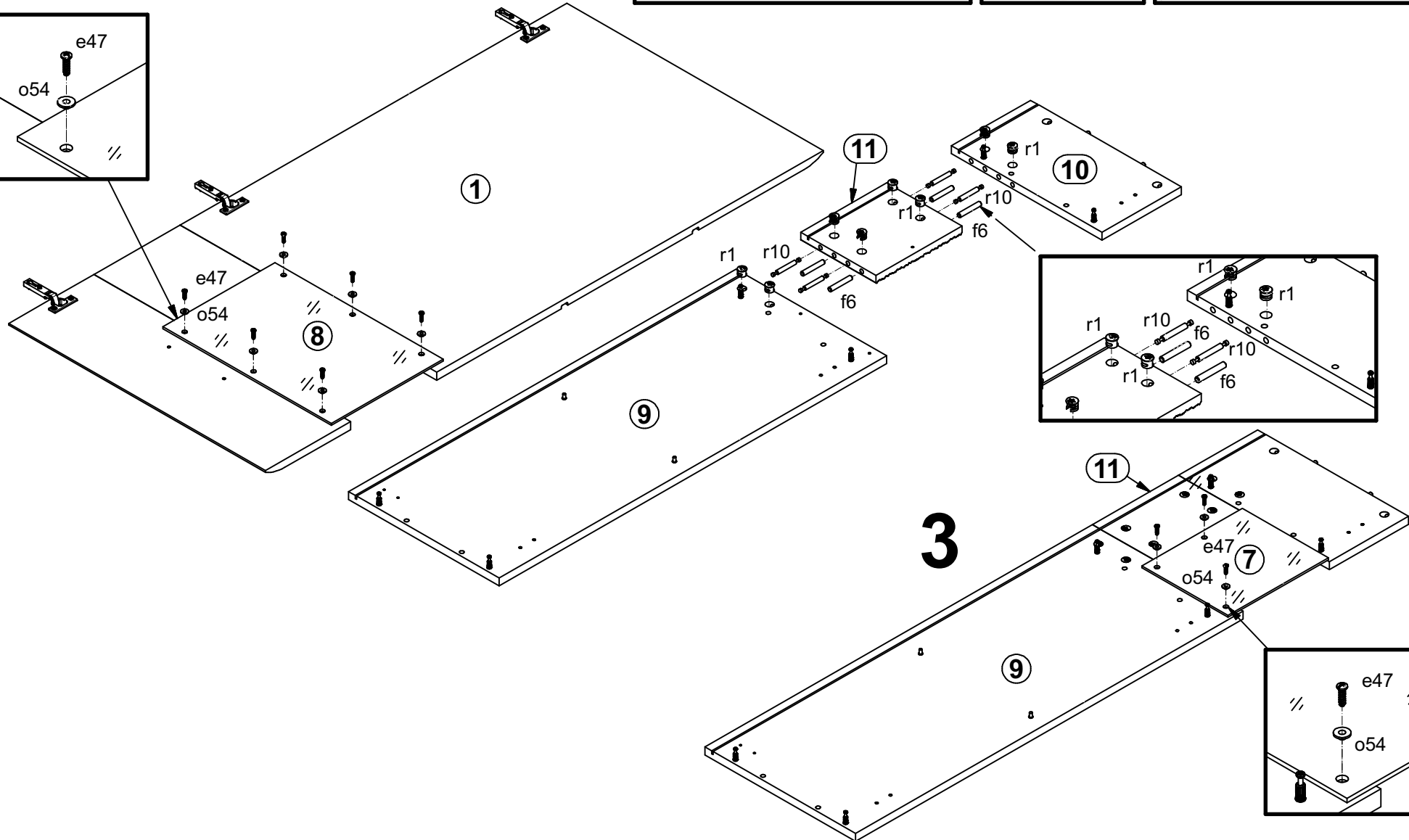
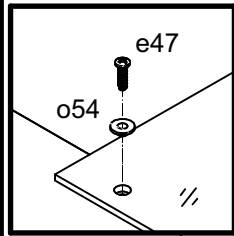
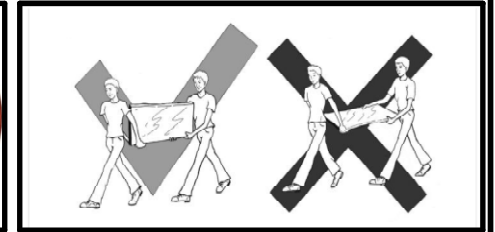
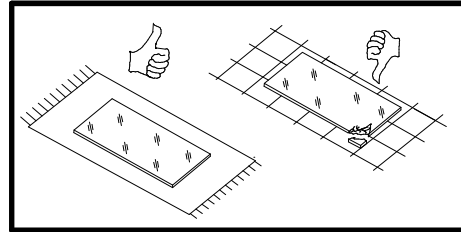

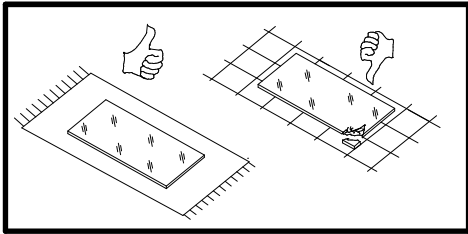

5

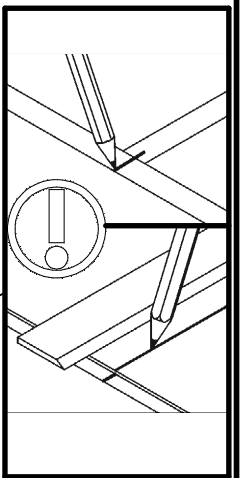

4

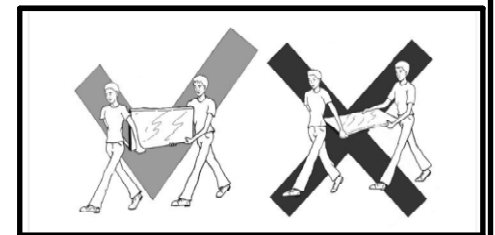
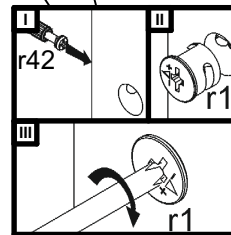
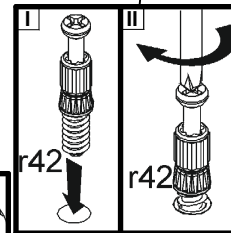
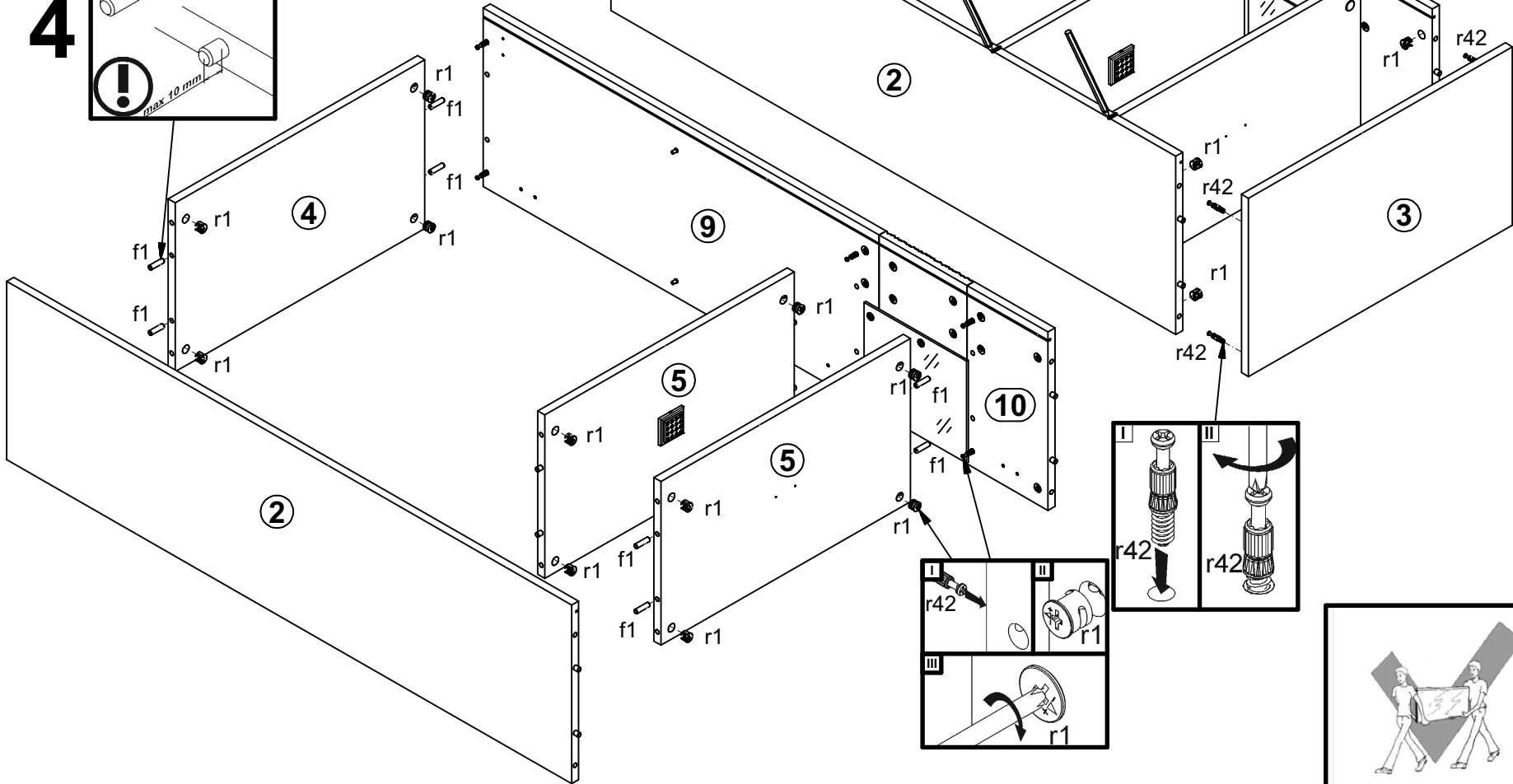
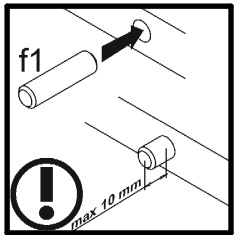

§11

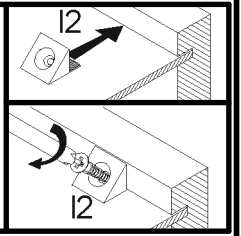
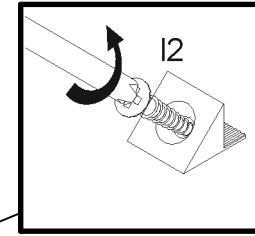
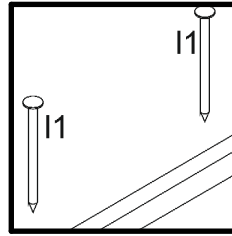
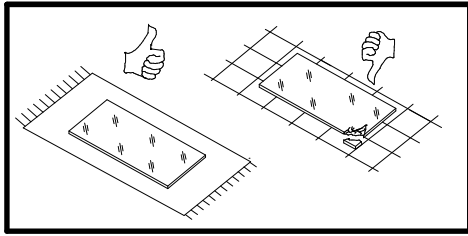

7

6

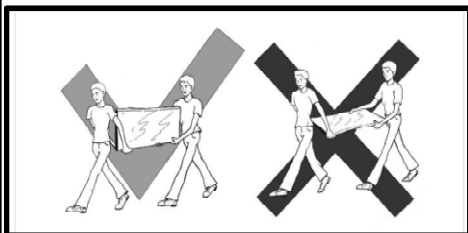
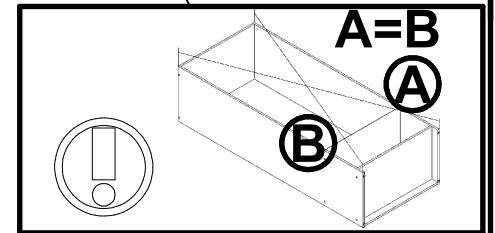
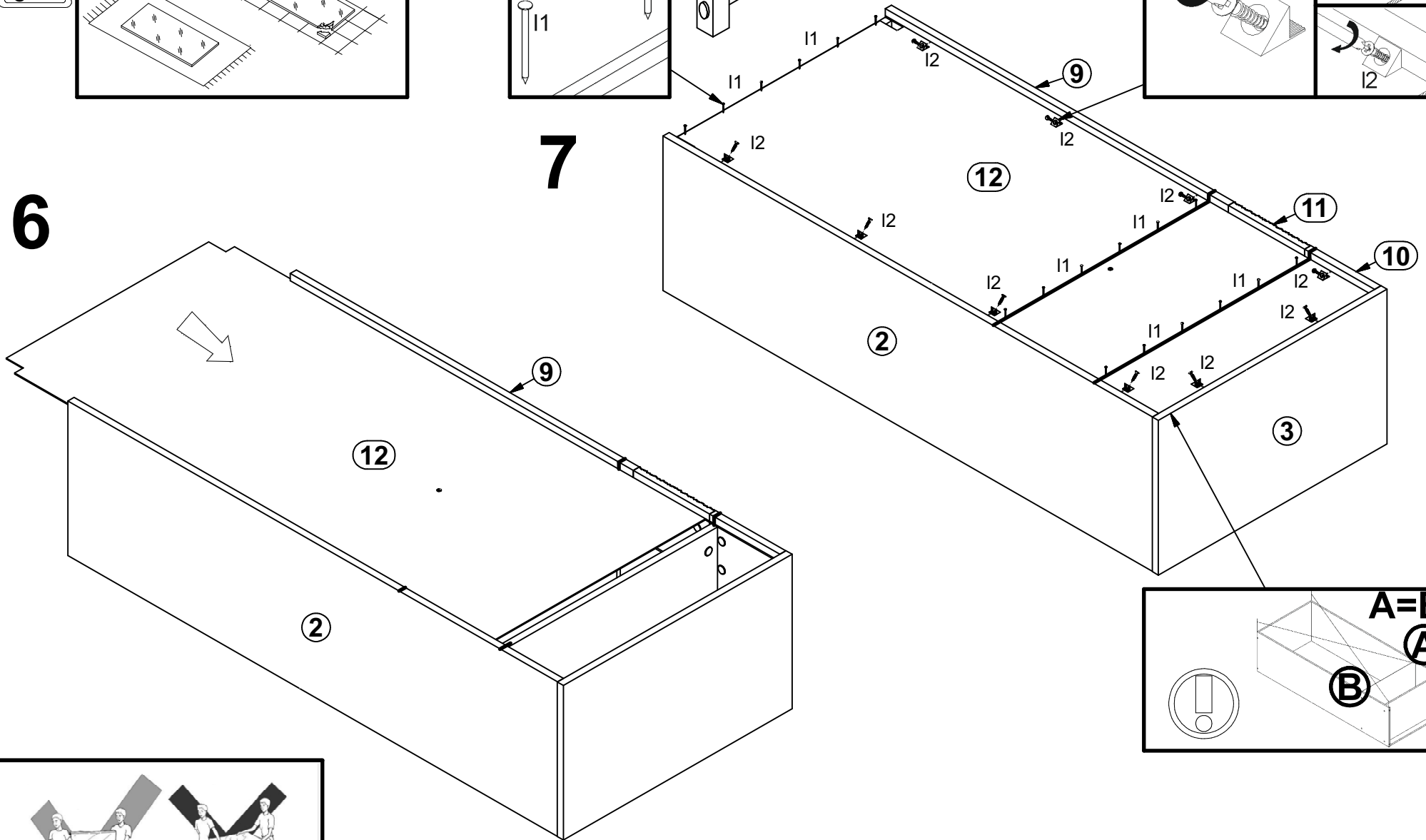

8

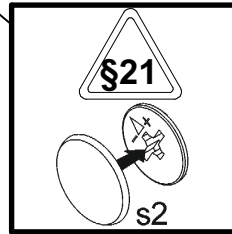
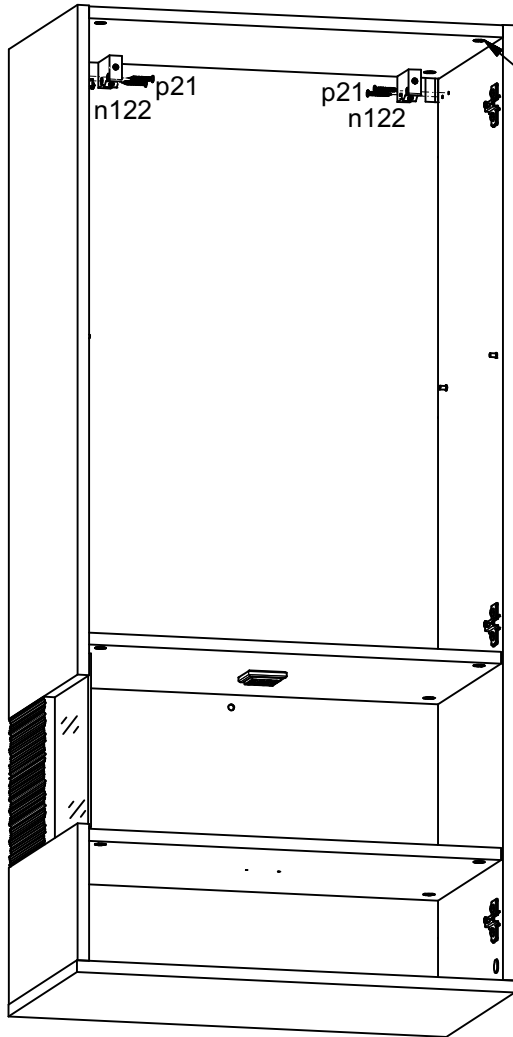
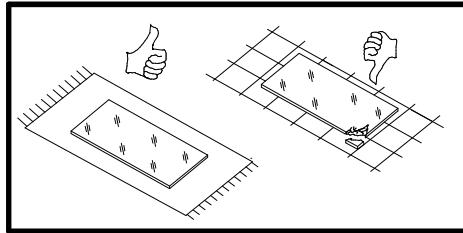
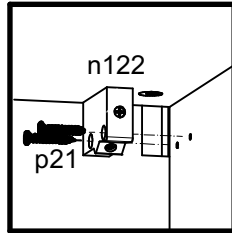

9

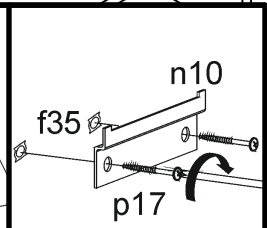
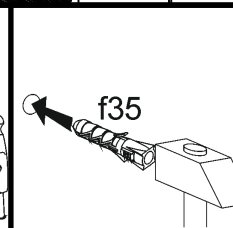
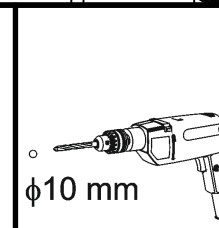
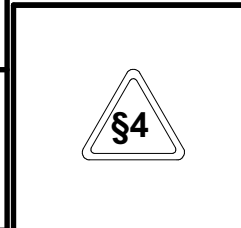
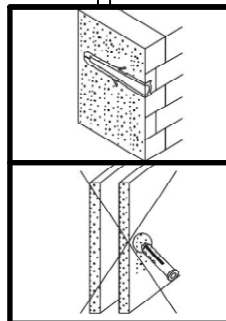
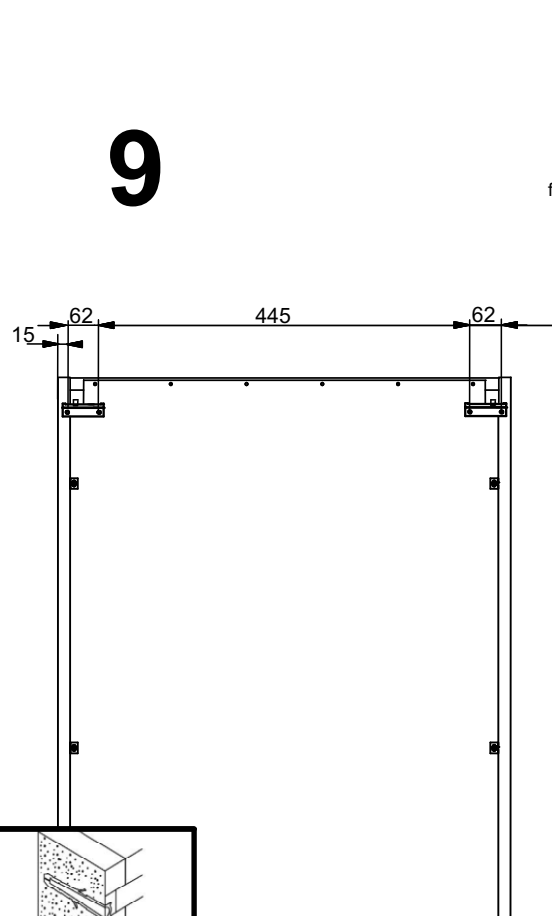

# 10

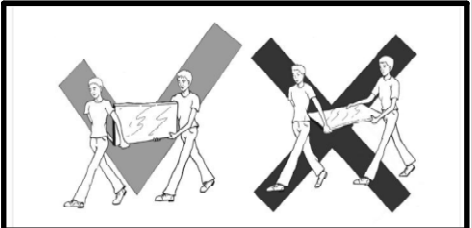
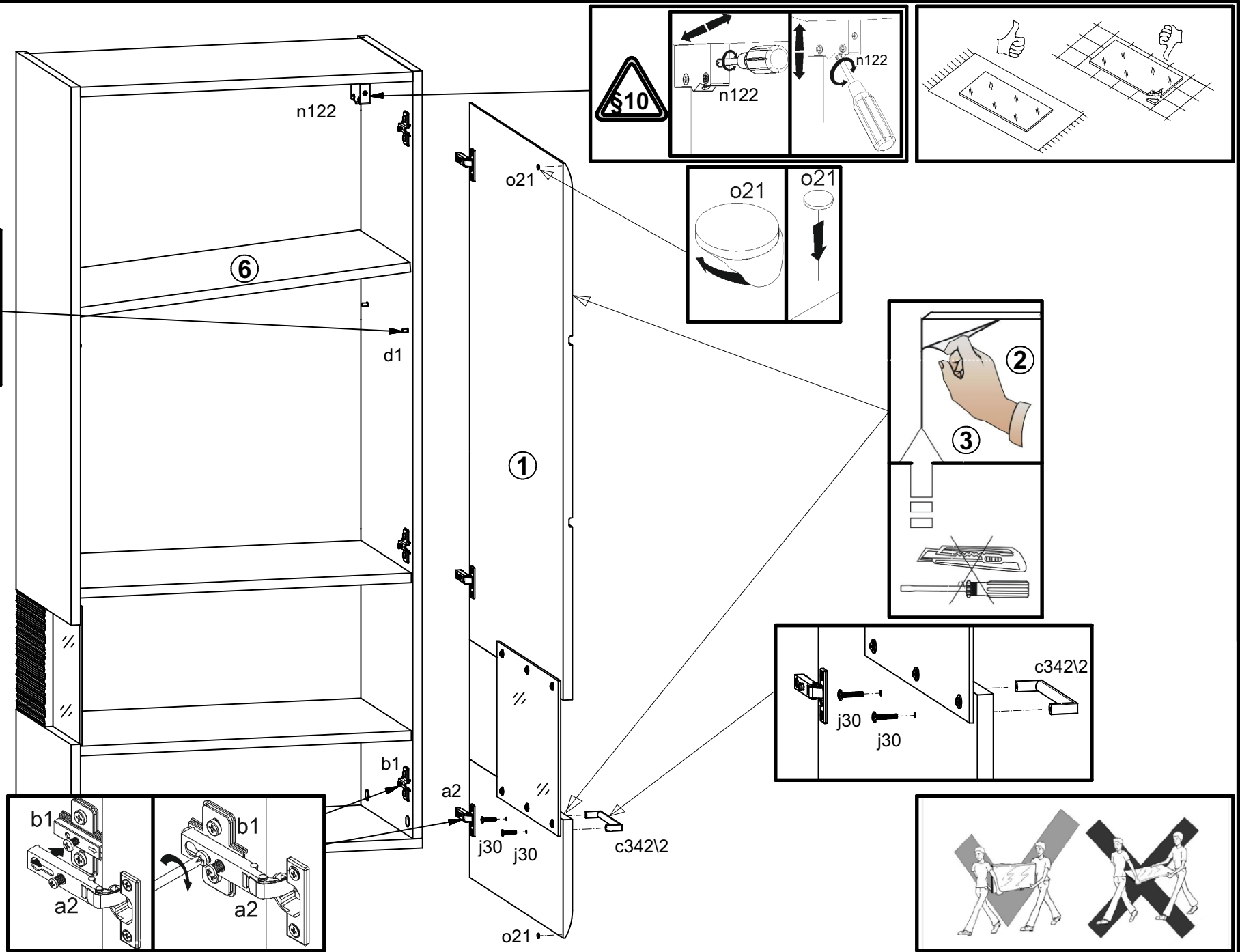
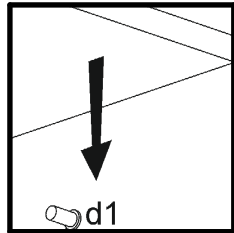

# 11

